

Simulation Model developed for a Small-Scale PV System in Distribution Networks

C. Koch-Ciobotaru*, L. Mihet-Popa*** F. Isleifsson** and H. Bindner**

* POLITEHNICA University/Automation and Computer Science, Timisoara, Romania

** Denmark Technical University/Electrical Engineering, Roskilde, Denmark
cosmin.koch@aut.upt.ro; lmih@elektro.dtu.dk

Abstract—This paper presents a PV panel simulation model using the single-diode four-parameter model based on data sheet values. The model was implemented first in MATLAB/Simulink, and the results have been compared with the data sheet values and characteristics of the PV panels in standard test conditions. Moreover to point out the strong dependency on ambient conditions and its influence on array operation and to validate simulation results with measured data a complex model has also been developed. A PV inverter model, using the same equations and parameters as in MATLAB/Simulink has also been developed and implemented in PowerFactory to study load flow, steady-state voltage stability and dynamic behavior of a distributed power system.

I. INTRODUCTION

Renewable energy systems are expanding due to not only environmental aspect but also due to social, economical and political interest. The European Union is aiming at a specific CO₂ reduction in the electricity sector in the near future (20 % reduction by 2020). This will involve a significant growth of PV installation all over Europe resulting in a few hundred Giga watts of capacity [1].

The increased PV capacity will influence power system operation and design. Power supplied from a PV array depends mostly on present ambient conditions such as: irradiation and temperature [2-5].

PV output voltage changes mainly with temperature while PV output current changes mainly with irradiation. Therefore in order to develop a very precise simulation model the local wind speed and the solar radiation incidence angle, in terms of the slope and surface azimuth, should be considered [5-8].

In order to determine the hourly incident radiation on a surface of any orientation it is necessary to evaluate the ratio of incident radiation on the tilted surface to that on a horizontal surface considering beam, sky diffuse and ground reflected radiation separately [3], [6], [9].

Increased distributed generation is becoming more important in the current power system and in the future it will rely more on distributed energy resources and micro-grids. The flexible micro-grid has to be able to import/export energy from/to the grid, control the active and reactive power flows and manage of the storage energy [7, 10, and 14].

This paper focuses on the simulation models of a small-scale PV System connected to a distributed network and on improvements and validating it using experimental

facility of an active and distributed power systems laboratory. In order to find out the differences between DER components in power systems and to study the impact on bus voltage and frequency the system has also been implemented in PowerFactory.

II. DISTRIBUTED ENERGY SYSTEM ARCHITECTURE. EXPERIMENTAL FACILITY

The experimental system is a laboratory for research in distributed control and smart grids with a high share of renewable energy production. Its experimental facility is a Wind/PV/Diesel Hybrid Mini-Grid with local storage and a novel control infrastructure. The facility is spread across three sites located several hundred meters apart.

It includes two wind turbines (11kW and 55kW), a PV-plant (7.8 kW), a diesel gen-set (48kW/60kVA), an intelligent office building with controllable loads (up to 20kW), a number of loads (75 kW, 3*36 kW) and a Vanadium Battery of 15 kW/190 kWh.

At each of the three sites there is a switchboard that allows the components installed at the site to be connected to either of two bus bars. The two bus bars at each site are connected to a crossbar switchboard allowing the flexible setup of the system(s) to be studied. The bus bars can be either connected to the national grid or can be part of an isolated system. It allows components and systems to be in grid connected operation, island operation, or operation in parallel with wind turbine or PV-plant.

A. PV Panels

The PV panels are mounted in three strings: two strings having 18 panels of 165 W each, and another one containing 12 panels of 100 W. The strings are connected to the grid through a three-phase PV inverter.

B. Data Acquisition and Control System

The data acquisition and control system (hardware and software) is responsible for the supervision and control of the research platform for distributed intelligent energy systems with a high penetration of renewable energy. The supervisory software code was written in Java and is able to manage the data acquisition, processes the data and executes the control loop and outputs the control variables. The sensors outputs are connected to a signal conditioning board, which in turn is connected to the data acquisition (DAQ) board based on a PC (SCADA System).

III. PV PANEL AND ARRAY MODELING

A. Modeling of the PV Panel

This paper uses a single diode equivalent circuit for the PV model, described by a simple exponential function:

$$i = I_{sc} - I_0 \cdot \left(e^{(v+iR_s)/n_s \cdot V_T} - 1 \right) \quad (1)$$

In which I_{sc} and I_0 are the short-circuit and open-circuit currents, R_s is the cell series resistance, n_s is the number of cells in the panel connected in series and V_T represents the junction thermal voltage which includes the diode quality factor, the Boltzmann's constant, the temperature at STC and the charge of the electron.

Manufacturers typically provide limited operational data for photovoltaic panels. These data are available only at standard rating conditions, for which the irradiance G_a is 1000 W/m^2 and the cell temperature T_{cell} is $25 \text{ }^\circ\text{C}$, except for the NOCT which is determined at 800 W/m^2 and an ambient temperature T_a of $20 \text{ }^\circ\text{C}$.

Equations for the short circuit current I_{sc} and the open circuit voltage V_{oc} as a function of absolute temperature ΔT include temperature coefficients that provide the rate of change with respect to temperature of the PV performance parameters, can be express as:

$$\begin{aligned} I_{sc} &= I_{sc25} \cdot (1 + \beta_I \cdot \Delta T) \\ V_{oc} &= V_{oc25} \cdot (1 + \chi \cdot \Delta T) \end{aligned} \quad (2)$$

$$\Delta T = T_{cell} - T_a$$

To complete the model it is also necessary to take into account the variation of the parameters with respect to irradiance:

$$I_{sc} = I_{sc25} \cdot (G_a / 1000) \quad (3)$$

Using a four parameters model of a single diode equivalent circuit, the v-i characteristics for a solar panel string depending on irradiance and temperature has the following expressions:

$$v = n_{ps} \cdot V_{oc} + n_{ps} \cdot n_s \cdot V_T \cdot \ln \left(1 - i / (n_{sp} \cdot I_{sc25} \cdot G_a / 1000) \right) \quad (4)$$

$$i = n_{sp} \cdot I_{sc} \cdot \left(1 - e^{(v - n_{ps} \cdot V_{oc} + R_s \cdot i) / (n_{ps} \cdot n_s \cdot v)} \right) \quad (5)$$

The equations (4) and (5) can be used to calculate the voltage and current over a string of panels.

The model used to obtain the static characteristics of the PV panels has been developed in MATLAB using the equations presented above. The model was developed for one panel, as a function of irradiance and temperature. The model has as inputs G_a and T_{cell} on the panel and it sweeps the voltage range of the PV panel in order to calculate the output current and power. PV cells have nonlinear i-v and p-v characteristics. Its output voltage and power change according to temperature and irradiation.

Fig. 1 shows the typical characteristics for a PV model and also a comparison between PV technical characteristics from datasheet (on the left) and simulation results for one panel.

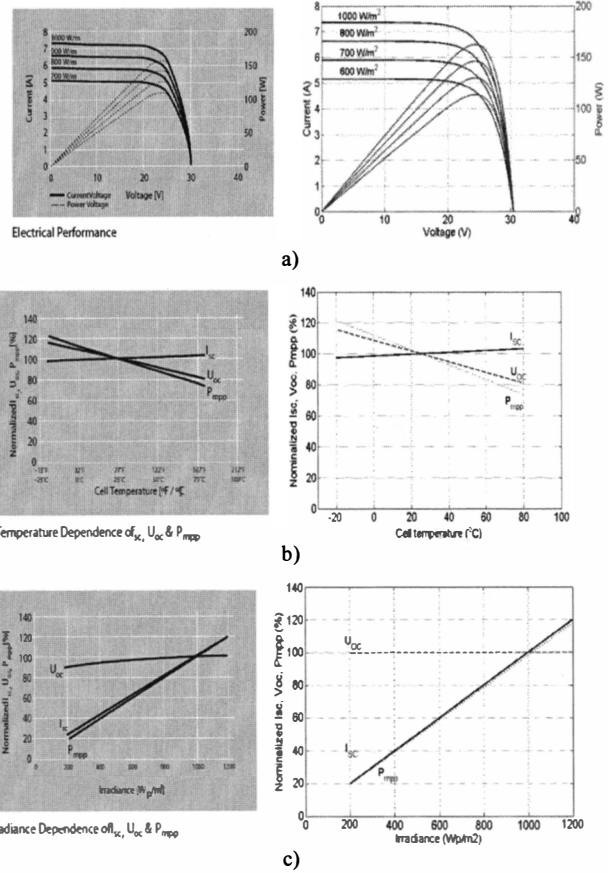

Fig. 1. Comparison between PV technical characteristics from datasheet (on the left) and simulation results for one panel.

B. Modeling of the PV Array

A MATLAB/Simulink model has been developed, based on the equations presented in the last section, in order to reproduce the electrical behavior of the existing PV strings at the experimental system. The model has the temperature and the solar radiance on the panel as inputs and the AC power at the inverters' grid side as output.

For obtaining the maximum power of the panel strings, the condition $(dp/dv=0)$ should be fulfilled.

The block diagram implemented in Simulink that was developed to implement this model is depicted in Fig. 2.

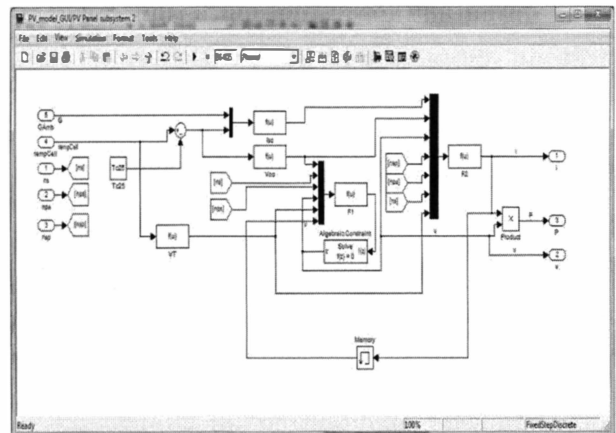

Fig. 2. PV string model implemented in Simulink

C. Improvements of the Model

Two types of measurements are taken from the experimental facility: ambient measurements from the weather station and electrical measurements taken from the inverter.

The three ambient measurements: ambient temperature, horizontal solar radiation, and wind speed are fed to a module that calculates the cell temperature of the PV panels and the solar radiation on them.

1) Cell Temperature

The cell temperature T_{cell} can be very different from the ambient temperature T_a and it depends on the solar irradiation G_a , T_a and also on the wind speed W_s . Solar irradiation acts on increasing T_{cell} and the wind speed has a cooling effect and lowers T_{cell} [3], [5].

If the PV panels are mounted in the regions with high wind potential (as in our case), the wind speed must be considered. The forced (wind) convection is large for high wind speeds and the cell temperature function takes the following form [5]:

$$T_{cell} = T_a + \omega \cdot (0.32 / (8.91 + 2 \cdot W_s / 0.67)) \cdot G_a \quad (6)$$

Where ω is the mounting coefficient, which depends on the mounting conditions of the PV panels and W_s is the wind speed measured on horizontal plane.

The wind that produces the cooling effect through forced convection is the wind parallel to the panel surface; that is why the transformation $W_{parallel} = W_s / 0.67$ is used.

For a better understanding on the influence of solar irradiance and wind speed on the cell temperature, a graphical representation of these values is depicted in Fig. 3. The differences in temperature of the PV cells according to different considerations are also presented.

2) Solar irradiance on the PV panel

The solar radiance has influence only on the current and implicitly on the output power of the PV panel, so the plots contain the effect of the change in the input solar irradiance, according to the 'adaptation' of the horizontal solar irradiance to the real case of the PV panel.

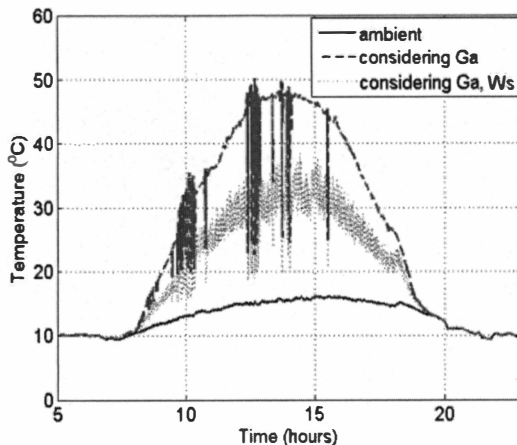

Fig. 3. Ambient measurements and their effect on the PV cell temperature.

The solar irradiance input to the model is the horizontal value measured from the weather station. This translates into substantial differences as can also be seen in Fig 3.

D. Simulation and validation of the array model

The simulation model, developed before in MATLAB/Simulink for one PV panel, has been improved and modified for a PV array with three strings. A block diagram of the model can be seen in Fig. 4.

The PV array model is based on the equations (1-3). These equations represent the PV characteristics taking into account the no. of strings in parallel and the no. of panels in series.

In Fig. 5 are presented the simulation results versus measurements at different stages of the modeling. These Figures also shows the importance of several factors that have to be taken in consideration, especially PV panel tilt angle and orientation.

Fig. 5 b) shows the same wave form for output power, with the same peak values, and the same changes in power due to shading effect in a synchronous manner. The simulation has a delay of around 50 minutes. This is the effect of the PV panels' orientation, which have a 13° deviation from the E-W axis.

Considering the tilt angle and orientation, the influence of solar irradiance and wind speed on the cell temperature the measurements and simulations are almost identically, as can be seen in Fig. 5 c).

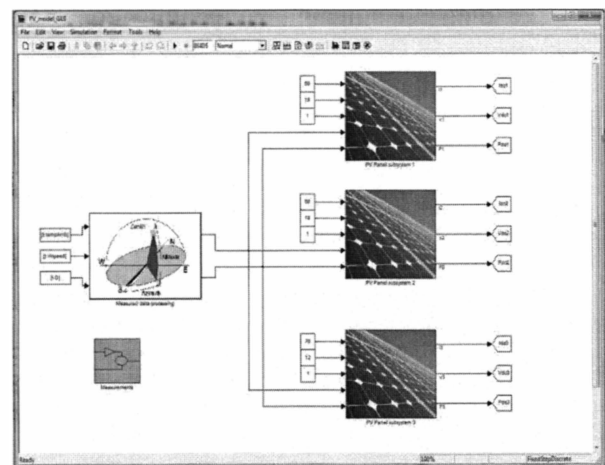
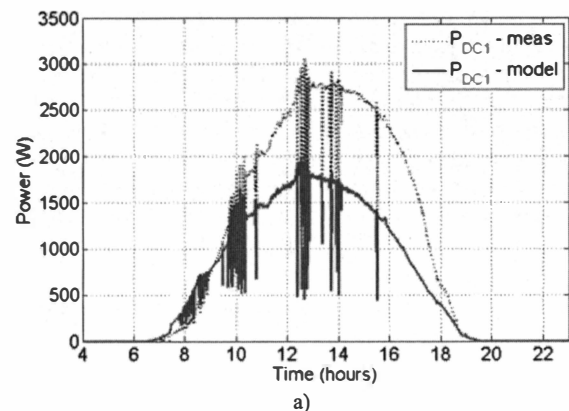

Fig. 4. Block diagram of the simulation model for PV array.



a)

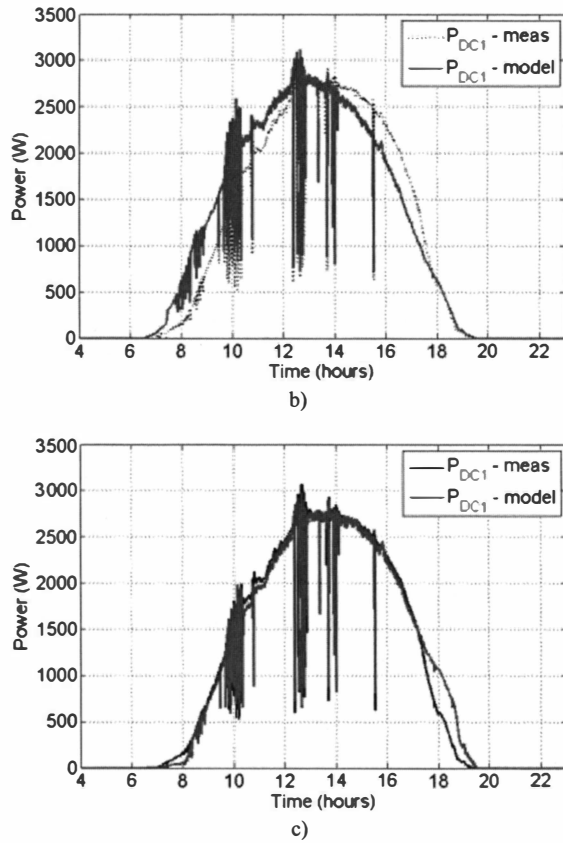

Fig. 5. Solar irradiance adaptation steps.

IV. SIMULATION MODEL OF THE PV SYSTEM DEVELOPED IN POWERFACTORY FOR DISTRIBUTION NETWORKS

Computer models of power systems are widely used by power system utilities to study load flow, steady-state voltage stability and dynamic and transient behavior of power system.

DIgSILENT PowerFactory has been chosen because provides the ability to simulate load flow, RMS fluctuations in the same software environment. It provides a comprehensive library of models for electrical components in the power system [14].

The dynamic model of the PV System implemented in PowerFactory has been built with standard components library and is based on the same equations used for MATLAB/Simulink model presented before.

The blocks of the PV model, DC-Link and controller of the Static Generator are implemented in the dynamic simulation language DSL of DIgSILENT. DSL allows the user to implement specific models that are not standard in the DIgSILENT library and thus to create own developed blocks either as modifications of existing models or as completely new models. The internal simulation language DSL has also been used to define the PV characteristics and to initialize the parameters and variables of the model.

Fig. 6 a) shows a single line diagram of the laboratory architecture implemented in PowerFactory.

Fig. 6 b) shows the schematic structure of the PV System model, developed for time-domain simulations

where a DSL model is required, including Photovoltaic Model, DC-Link Model, PLL block and Static Generator with its Controller. The Static Generator is an easy to use model of any kind of static (non rotating) generators. The common characteristic of these generators is that they are all connected to the grid through a static converter. Applications are PV Generators, Storage devices, wind generators etc.

On the basic data tab of the single line diagram it is possible to set up the number of parallel generators and the power ratings of one PV panel.

For load flow analysis, also shown in Fig. 6 a), the local voltage controller could be set to three different modes: $\cos\phi$, V and droop.

For RMS and EMT simulations the static generator supports two different models: controlled current and voltage source models. In our case we use a controlled current source model which has as inputs d-q axis reference current coming from the controller and d-q reference angles ($\cos\text{ref}$ and $\sin\text{ref}$) from a PLL built-in model.

Photovoltaic Model has as inputs irradiation G and cell temperature tempCell , obtained from MATLAB-Simulink model considering the tilt angle, orientation and the influence of solar irradiation and wind speed on the cell temperature (Fig. 4), implemented as a look-up table, as can be seen in Fig. 7. Also the MPP of current, power and voltage as a function of time for one module are shown.

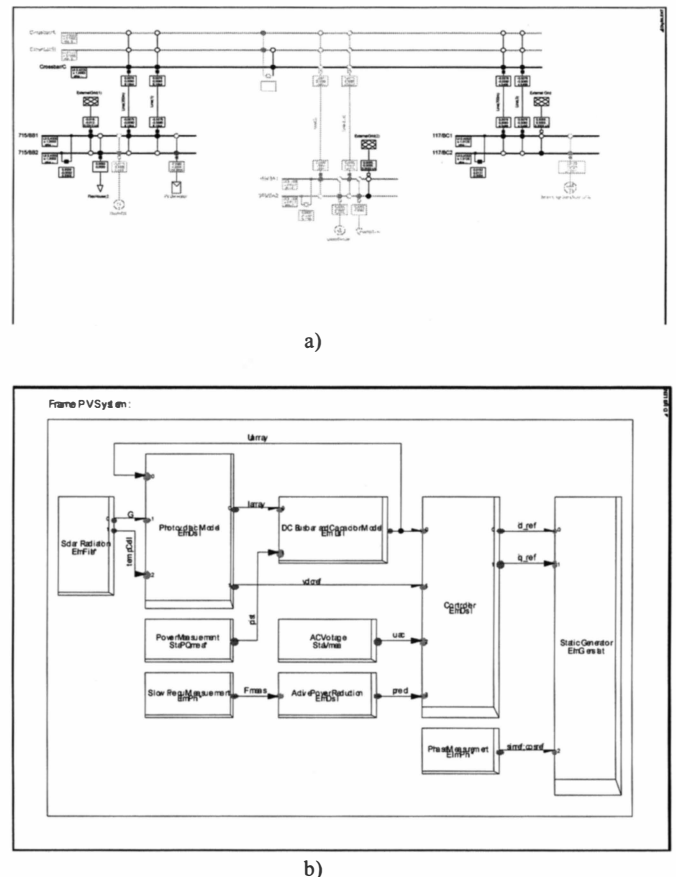

Fig. 6. a) Single line diagram of SYSLAB configuration implemented in PowerFactory and b) schematic block diagram of the PV system model.

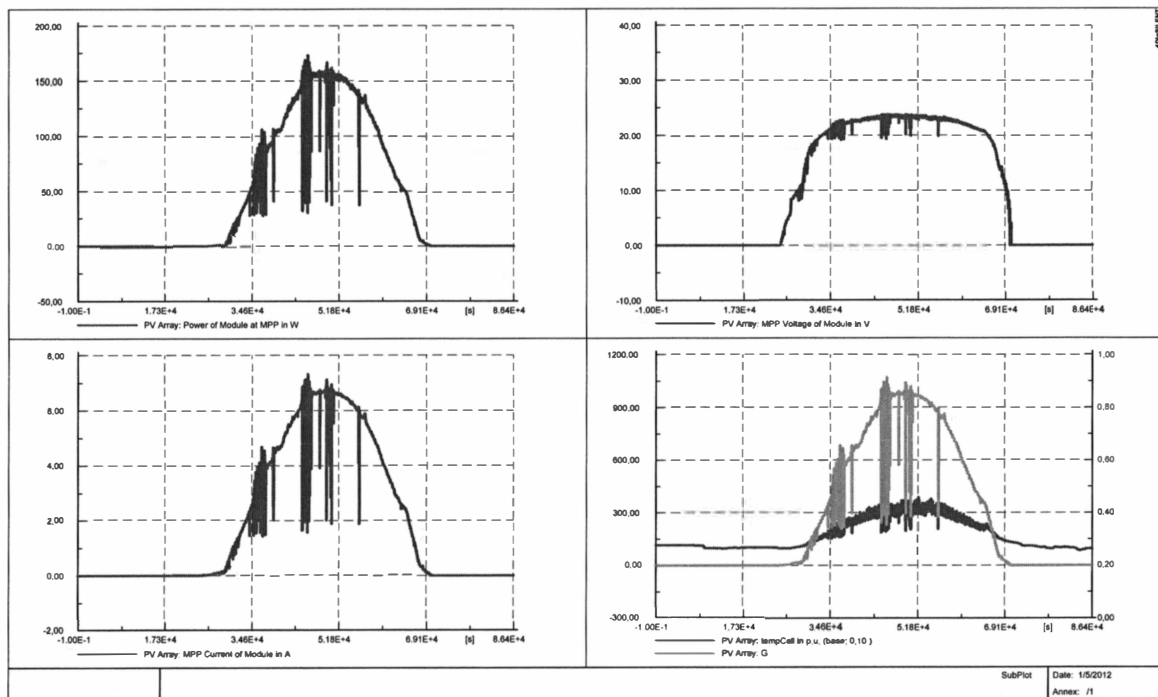

Fig. 7. Simulation results of the PV system model implemented in PowerFactory

V. CONCLUSIONS

This paper proposes a four-parameter model of a PV panel and a PV system, implemented in MATLAB/Simulink, using data provided by the manufacturer with semi-empirical equations to predict the PV characteristics for any condition. PV characteristics are modeled according to a single diode four parameter equivalent circuit and PV parameters values taken from the manufacturer technical data.

The paper also proposes a model that relies on ambient data from a local weather station, like most common in a real situation, not from sensors mounted on the PV panels. The model calculates the cell temperature and the solar irradiance on the PV panels considering, among others, the tilt angle, the orientation of the panels, and the wind cooling effect. The paper shows that these factors significantly influence the power output from the PV panels.

Comparison with experimental data, acquired by SCADA system and processed by MATLAB, and with the characteristics of the PV panels, provided by manufacturers, has shown that the model implemented in MATLAB/Simulink can be an accurate tool for the prediction of energy production.

A PV system model, using the same equations and parameters as in MATLAB/Simulink to define the PV module and characteristics, has also been developed and implemented in PowerFactory to study load flow, steady-state voltage stability and dynamic behavior of a distributed power system.

A comparison between both simulation models, implemented in MATLAB/Simulink and PowerFactory, has shown a good similarity. That means that this work can be used for further development of tools for DER components in a distributed network.

ACKNOWLEDGMENT

This work was supported in part by the E.U. Project-Smooth PV, No. 228449/2011 and also partially supported by the strategic grant POSDRU/88/1.5/S/50783 (2009) of the Ministry of Labor, Family and Social Protection, Romania, co-financed by the European Social Fund – Investing in people.

REFERENCES

- [1] *** www.energynautics.com, Energynautics GmbH, Longen, Germany, 2010.
- [2] S. Seme, G. Stumberg, and J. Vorsic, "Maximum efficiency trajectories of a two-axis sun tracking system determined considering tracking system consumption", *IEEE Trans. On Power Electronics*, vol. 26, no. 4, pp. 1280-1290, Apr. 2011.
- [3] W. De. Soto, S. A. Klein, and W. A. Beckman, "Improvement and validation of a model for photovoltaic array performance", *ELSEVIER Solar Energy*, vol. 80, pp. 78-88, 2006.
- [4] Y. Riffonneau, S. Bacha, S. Barruel and S. Ploix, "Optimal Power Management for grid connected PV Systems with batteries", *IEEE Transaction on Sustainable Energy*, vol. 2, no. 3, pp. 309-320, July 2011.
- [5] E. Skoplaski, A. G. Boudouvis and J. A. Polyvos, "A simple correlation for the operating temperature of photovoltaic modules of arbitrary mounting", *ELSEVIER Solar Energy Materials*, pp. 1393-1402, 2008.
- [6] K. Murat, S. Mehmet, B. Yunus, D. Sedat, "Determining optimum tilt angles and orientations of photovoltaic panels in Saliurfa", *IEEE Transaction on Renewable Energy*, vol. 29, issue 8, pp. 1265-1275, 2004.
- [7] H. Jiayi, J. Chuanwen, and X. Rong, "A review on distributed energy resources and MicroGrid", *ELSEVIER Renewable & Sustainable Energy Reviews*, vol. 12, pp. 2472-2483, 2008.
- [8] M. G. Villalva, J. R. Gazoli, E. R. Filho, "Comprehensive Approach to Modelling and Simulation of Photovoltaic Arrays", *IEEE Transaction on Power Electronics*, vol. 24, issue: 5, pp. 1198-1208, 2009.
- [9] D. Y. Goswami, *Principles of Solar Engineering*, (2nd ed.), Philadelphia: Taylor & Francis, 2000, p. 81-98.

- [10] M. Jansen, R. Louie, M. E. Amoli and F. Sami, "Model and simulation of a 75 kW PV solar array", in Proc. 2010 IEEE PES Transmission and Distribution Conference and Exposition, pp. 1-5.
- [11] S. Dezso; Teodorescu R.; and Rodriguez P., "PV panel model based on datasheet values", in Proc. 2007 IEEE International Symposium on Industrial Electronics, pp. 2392-2396.
- [12] H. Liu, L. Jin, D. Le and A. A. Chowdhury, "Impact of high penetration of solar photovoltaic generation on power system small signal stability", in Proc. 2010 POWERCON, pp. 1-7.
- [13] A.D. Hansen, P. Sørensen, L.H. Hansen, H. Bindner, "Models for a Stand-Alone PV System", Risø National Laboratory, Roskilde, Risø-R-1219(EN) / SEC-R-12, Dec. 2000.
- [14] DIGSILENT PowerFactory, Digsilent gmbh, November 2010.